

Dati tecnici contenitore antideflagrante

Classificazione ATEX	II 2 G Ex-d IIC T6
Temperatura ambiente	-20°C...+40°C
Protezione	IP65 vedi pagina 8
Materiale	Lega primaria di alluminio

Explosion-resistant box specifications

ATEX approval	II 2 G Ex-d IIC T6
Environment temperature	-20°C to +40°C
Protection	IP65 see page 8
Material	Primary aluminium alloy

Dati tecnici pressostato

Campo di lavoro	0.2...50 bar (secondo modello scelto)
Differenziale	Dal 10% al 30% del valore di taratura
Portata contatti	6 (2) A / 250 Vca
Campo di temperatura	-20°C...+40°C
Pressione massima	80...300 bar (secondo modello scelto)
Numero max. interventi a 25°C	120/min. (membrana)
Vita meccanica	10 ⁶ cicli
Contatti elettrici	SPDT

Pressure switch specifications

Adjustment range	0.2 to 50 bar (according to model required)
Hysteresis	From 10% to 30% of set-point value
Switch rating	6 (2) A / 250 Vac
Temperature range	-20°C to +40°C
Max. pressure	80 to 300 bar (according to model required)
Max. cycle rate at 25°C	120/min. operations (diaphragm type)
Mechanical life	10 ⁶ operations
Electrical contacts	SPDT

SIGLA DI ORDINAZIONE / HOW TO ORDER

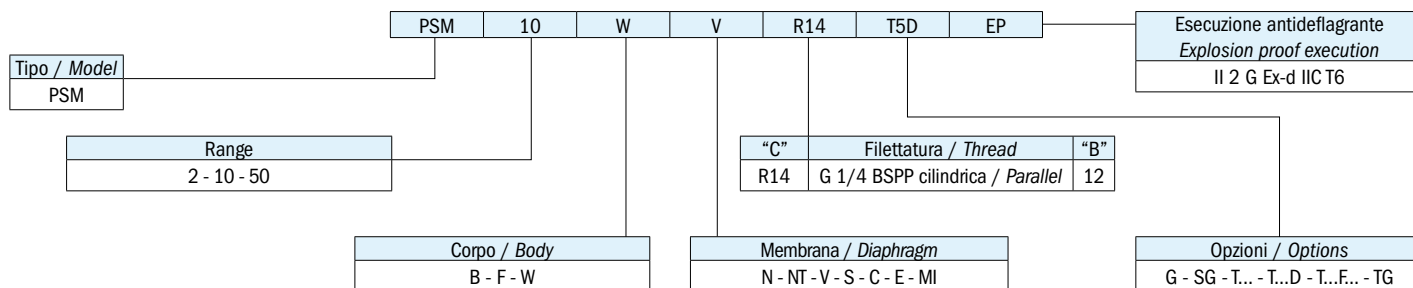

SPIEGAZIONE DELLE SIGLE DI ORDINAZIONE / ORDERING INFORMATION

PSM...	Pressostato con contatti SPDT a membrana
PSP...	Pressostato con contatti SPDT a pistone
Materiale corpo Ch 27	B Ottone F Acciaio zincato W AISI 316 a richiesta su tutti i modelli
Membrana disponibile/ Guarnizioni	N NBR (standard) (-5°C...+90°C) NT HNBR (-25°C...+140°C) V FKM (-5°C...+90°C) S Silicone (-30°C...+120°C) C Neoprene (-10°C...+90°C) E EPDM (-20°C...+110°C) MI Acciaio Inox (-30°C...+140°C) (solo PSM2 e PSM10)
Filettature disponibili	R14 G 1/4 BSPP cilindrica
Opzioni	G Contatti dorati per bassa corrente SG Sgrassati per utilizzo con ossigeno T... Taratura in salita al valore richiesto (es. T2 taratura a 2 bar) T...D Taratura in discesa al valore richiesto (es. T2D taratura in discesa a 2 bar) T...F... Taratura del pressostato e del differenziale se >10% max. 30% valore taratura (es. T40 F10 taratura in salita a 40 bar con differenziale di 10 bar) TARATURA IN ELETTROTEC TG Testati per utilizzo con gas

PSM...	Diaphragm pressure switch with SPDT contacts
PSP...	Piston pressure switch with SPDT contacts
27 AF body material	B Brass F Zinc plated steel W S.s. 316 on request for all models
Available diaphragm/ seal	N NBR (standard) (-5°C to +90°C) NT HNBR (-25°C to +140°C) V FKM (-5°C to +90°C) S Silicone (-30°C to +120°C) C Neoprene (-10°C to +90°C) E EPDM (-20°C to +110°C) MI Stainless steel (-30°C to +140°C) (only PSM2 and PSM10)
Available threads	R14 G 1/4 BSPP parallel
Options	G Gold-plated contacts for low current SG Degreased for applications with oxygen T... Set-point rising to the required value (ex. T2 rising set-point adjustment at 2 bar) T...D Set-point falling to the required value (ex. T5D falling set-point adjustment at 5 bar) T...F... Set-point and hysteresis at the required value if > 10% max. 30% of set-point (ex. T40F10 set-point at 40 bar with hysteresis at 10 bar) FACTORY SETTING TG Tested for applications with gas

IN CONFORMITÀ ALLA DIRETTIVA 2014/30/CE.

IN COMPLIANCE WITH DIRECTIVE 2014/30/CE.

CARATTERISTICHE GENERALI / GENERAL SPECIFICATIONS

TIPO MODEL	CAMPO DI LAVORO PRESSIONI RELATIVE ADJUSTMENT RELATIVE PRESSURE RANGE bar	DIMENSIONI "A" DIMENSIONS "A" mm	MAX. PRESSIONE STATICA SUPPORTABILE MAX. STATIC PRESSURE bar			TOLLERANZA D'INTERVENTO A 25°C TOLERANCE AT 25°C bar	ESECUZIONE EXECUTION
			ESEC. CORPO OTTONE EXECUTION BRASS	ESEC. CORPO ACCIAIO ZINCATO ZINC PLATED BODY EXECUTION	ESEC. CORPO ACCIAIO INOX 316 S.S. 316 EXECUTION		
PSM 2...EP	0.2 - 2	165	80	300	150	±0.2	Membrana Diaphragm
PSM 10...EP	1 - 10		80	300	150	±0.4	
PSM 50...EP	10 - 50		80	300	150	±2	

Elettrotec si riserva la facoltà di apportare modifiche tecniche ai prodotti o di cessarne la produzione senza obbligo di preavviso. Il contatto del pressostato può danneggiarsi quando sottoposto a forti urti o ad alte vibrazioni. È responsabilità dell'utilizzatore verificare l'idoneità dei nostri prodotti per ogni particolare applicazione (ad esempio, la verifica della compatibilità dei materiali) e l'uso può essere appropriato solo se dimostrato in test sul campo. Le informazioni tecniche in questo catalogo si basano su prove effettuate durante lo sviluppo del prodotto e in base ai valori empiricamente raccolti. Essi non possono essere applicabili in tutti i casi.

Elettrotec reserves the right to technical data of change to the products or halt production without prior notice. The pressure switch contacts can be damaged when subject to strong shocks or high vibration. It is the responsibility of the user to test the suitability of our products for the particular application, for example, the verification of material compatibility. The use may only be appropriate if proven in field tests. The technical information in this catalogue are based on tests made during product development and based on empirically gathered values. They may not be applicable in all cases.

DATI TECNICI GENERALI GENERAL TECHNICAL DATA

PRESSOSTATO A MEMBRANA, CONTATTO NC
DIAPHRAGM PRESSURE SWITCH, NC CONTACT

SENZA PRESSIONE
WITHOUT PRESSURE

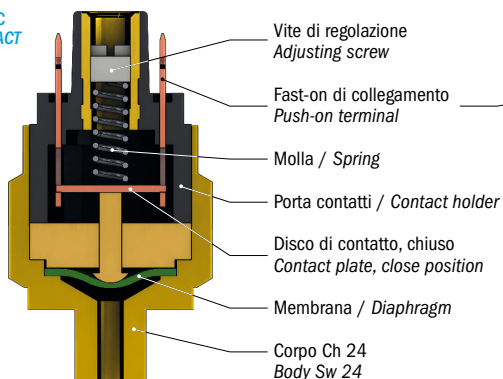

CON PRESSIONE
WITH PRESSURE

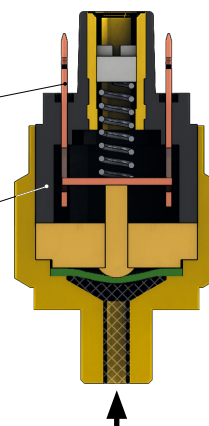

PRESSOSTATO A MEMBRANA, CONTATTO NA
DIAPHRAGM PRESSURE SWITCH, NO CONTACT

SENZA PRESSIONE
WITHOUT PRESSURE

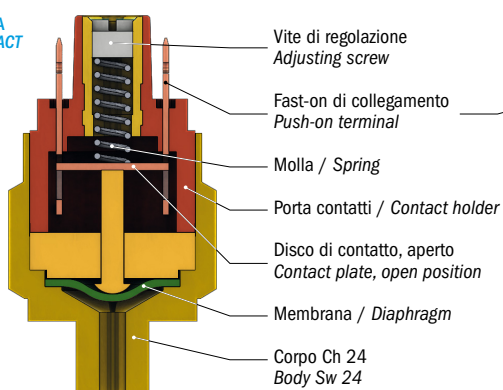

CON PRESSIONE
WITH PRESSURE

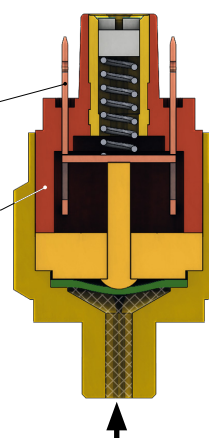

COPIE DI SERRAGGIO CONSIGLIATE / RECOMMENDED TIGHTENING TORQUES

Ottone / Brass		Acciaio zincato Zinc plated steel		AISI 316 / S.s. 316	
Filetto Thread	Coppia di serraggio* Recommended tightening torque Nm	Filetto Thread	Coppia di serraggio* Recommended tightening torque Nm	Filetto Thread	Coppia di serraggio* Recommended tightening torque Nm
R18	17	R18	22	R18	24
18K	17	18K	22	18K	24
18NPT	17	18NPT	22	18NPT	24
5/8UNF	30	5/8UNF	40	5/8UNF	45
R12	40	R12	55	R12	60
R14	25	R14	35	R14	40
14K	25	14K	35	14K	40
14NPT	25	14NPT	35	14NPT	40
M10	18	M10	25	M10	30
M12	23	M12	32	M12	35
10K	18	10K	25	10K	30
34K	50	34K	70	34K	80

TIPOLOGIA DI CONTATTI ELETTRICI UTILIZZATI / ELECTRICAL CONTACTS APPLIED













Contatti / Contacts			Normativa DIN-EN-60947-5-1 Standard DIN-EN-60947-5-1	Simbolo IEC 60617 Symbol IEC 60617
NA	NA normalmente aperto NO normally open	SPST (single pole, single throw)	X	
NC	NC normalmente chiuso NC normally closed	SPST (single pole, single throw)	Y	
SC	SC contatti in scambio CO change over (snap action)	SPDT (single pole, double throw)	C	

* Una scorretta coppia di serraggio può influenzare la durata della macchina del pressostato. Variando tipologia di materiale utilizzato per realizzare il corpo del pressostato, varierà anche la coppia di serraggio.

* Improper torque may affect the mechanical life of the switch. The relevant legislation has been expressed in various ways. By varying the type of material used to make the switch body, will also vary the tightening torque.

PRESSOSTATI / PRESSURE SWITCHES

PROTEZIONI ELETTRICHE ELECTRIC PROTECTIONS

Pagina / Page		PMN	PMM	PM250	MS	PS	PSM PSP	PMC PMC...D	PPC PPCF	PPC...D PPCF...D	PML	PPL	PSK	MPS	PHP	PHC		
Protezione IP 54 <i>IP 54 electric protection</i>		9	11	13	15	15	17...24	25	27	27	29	29	31	33	35	37		
Protezione IP 54 <i>IP 54 electric protection</i> CAP. 1  CAP. 10  CAP. 12  CAP. 16  CAP. 30  CAP. 31 		●	●	●												●		
		●	●														●	
								●										
						●	●								●			
																		●
																		●
Protezione IP 65 <i>IP 65 electric protection</i> CAP. 3  CAP. 13  Connettore DIN 40050 <i>DIN 40050 connector</i> 		●	●	●													●	
						●	●											
								●	●	●	●	●	●	●	●			
Protezione IP 67 <i>IP 67 electric protection</i> CAP. 14 + cavi + connettore <i>CAP. 14 + flying leads + connector</i>  Connettore M12 / M12 connector  Deutsch DT04-2P integrato 		●		●	●	●											●	
						●	●	●	●	●	●	●	●	●	●			
																●		
DATI ELETTRICI <i>ELECTRIC DATA</i>		PMN	PMM	PM250	MS	PS	PSM PSP	PMC PMC...D	PPC PPCF	PPC...D PPCF...D	PML	PPL	PSK	MPS	PHP	PHC		
Tensione di alimentazione / Power supply	12 Vca/cc	●	●	●	●	●	●	●	●	●	●	●	●	●	●	●	●	
	24 Vca/cc	●	●	●	●	●	●	●	●	●	●	●	●	●	●	●	●	
	48 Vca/cc	●	●	●	●	●	●	●	●	●	●	●	●	●	●	●	●	
	110 Vca/cc			●	●	●	●	●	●	●	●	●	●	●	●	●	●	
	220 Vca/cc			●	●	●	●	●	●	●	●	●	●	●	●	●	●	
	250 Vca/cc			●	●	●	●	●	●	●	●	●	●	●	●	●	●	
Corrente massima / Max. current	< 30 mA	●	●	●	●	●	●	●	●	●	●	●	●	●	●	●	●	
	0.5 A	●	●	●													●	
	3 A							●	●	●	●	●	●					
	4 A																●	
	6 A					●	●	●										
	7 A													●				
	8 A																●	
	10 A							●	●	●	●	●	●	●				
15 A																●		
Contatti argentati / Silver plated contacts		●	●	●	●	●	●	●	●	●	●	●	●	●	●	●	●	
Contatti dorati / Gold plated contacts		●	●	●	●	●	●	●	●	●	●	●	●	●	●	●	●	
Isteresi fissa / Fixed hysteresis		●	●	●	●	●	●	●	●	●	●	●	●	●	●	●	●	
Isteresi regolabile / Adjustable hysteresis							●											
Corpo Ch 24 / Body 24 AF		●	●	●	●	●					●	●		●	●			
Corpo Ch 27 / Body 27 AF							●											

Elettrotec si riserva la facoltà di apportare modifiche tecniche ai prodotti o di cessarne la produzione senza obbligo di preavviso. Il contatto del pressostato può danneggiarsi quando sottoposto a forti urti o ad alte vibrazioni. È responsabilità dell'utilizzatore verificare l'idoneità dei nostri prodotti per ogni particolare applicazione (ad esempio, la verifica della compatibilità dei materiali) e l'uso può essere appropriato solo se dimostrato in test sul campo. Le informazioni tecniche in questo catalogo si basano su prove effettuate durante lo sviluppo del prodotto e in base ai valori empiricamente raccolti. Essi non possono essere applicabili in tutti i casi.

Elettrotec reserves the right to technical data of change to the products or halt production without prior notice. The pressure switch contacts can be damaged when subject to strong shocks or high vibration. It is the responsibility of the user to test the suitability of our products for the particular application, for example, the verification of material compatibility. The use may only be appropriate if proven in field tests. The technical information in this catalogue are based on tests made during product development and based on empirically gathered values. They may not be applicable in all cases.